

AA



**CHANGO
MOTORS**

PORTACELULAR ANTIVIBRACION



CHANGO
MOTORS

CÓD: **RZ-060**

Case protector de
lluvia - DESMONTABLE



Sistema
Anti vibración

Brazos Graduables
UNIVERSAL

Base de Carga
Inalambrica

Sistema de
sujecion segura
360°

CARACTERÍSTICAS

PARA ESPEJO

- Carga inalámbrica de tu dispositivo 15w
- Potencia de carga 10-24w
- Sistema anti vibraciones
- FACIL DE INSTALAR
- UNIVERSAL

S/. 125



CÓD: RZ-062



PORTA CELULAR DEMON

CARACTERÍSTICAS

- Carga rapida 2A
- Puerto de Carga USB
- Material: Aluminio
- Acoplable a timón

S/. 38

PORTA CELULAR ESCOICOY



CÓD: **RZ-020**



CARACTERÍSTICAS

- Carga rapida 2A
- Puerto de Carga USB
- Material: Aluminio
- Acoplable a espejo

S/. 38

PORTA CELULAR TIPO ARAÑA

CÓD: RZ-022



CARACTERÍSTICAS

- Carga rapida 2A
- Puerto de Carga USB
- Material: Aluminio
- Acoplable a espejo

S/. 32





cód: V-1

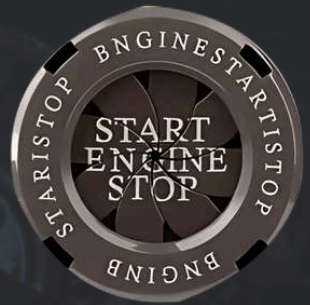

Protector de sistema de encendido

CARACTERÍSTICAS

- Colores surtidos
- Material de aluminio

S/. 18

RELOJ BIKER

CÓD: RV-002



CARACTERÍSTICAS

- Universal adaptable en el manillar

S/. 25



ADORNO DE LUJO

TORNILLO

CÓD: RZ-026

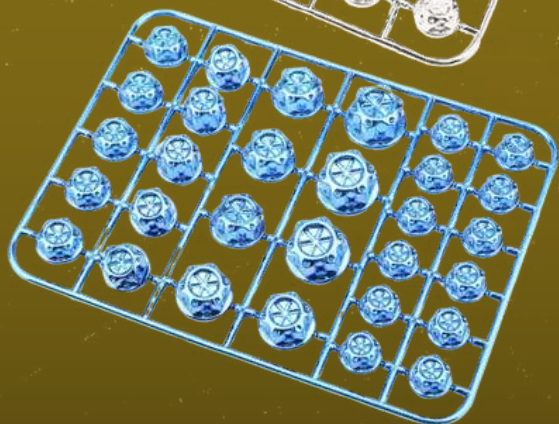
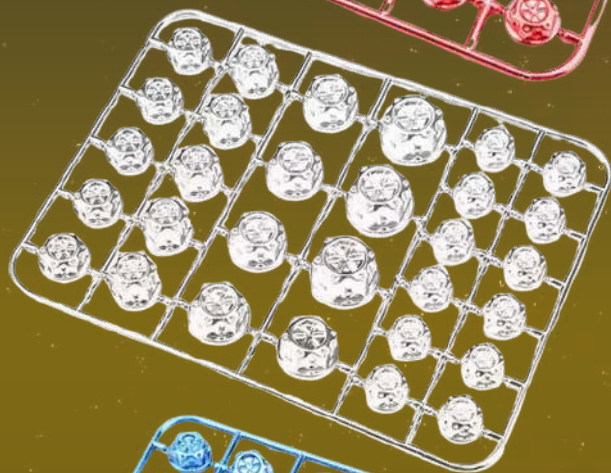
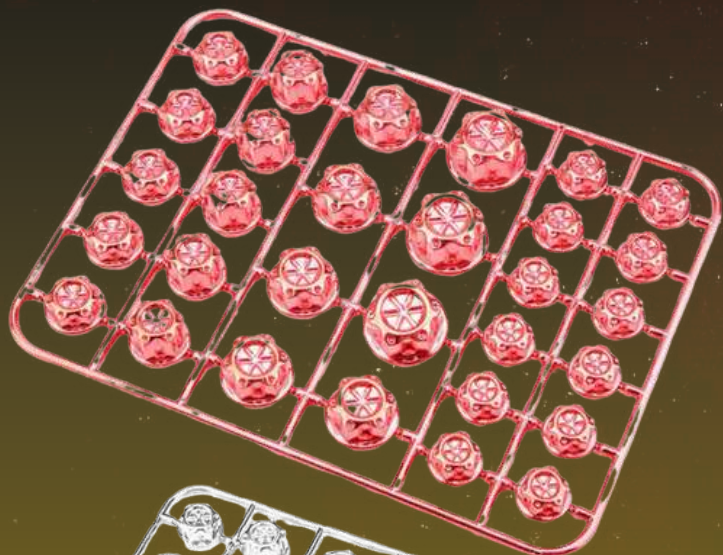

CARACTERÍSTICAS

- Adaptable a cualquier tipo de pernos
- Set de 48 piezas
- Protector de pernos decorativos

S/. 18



**CHANGO
MOTORS**



**CHANGO
MOTORS**

CÓD: RZ-028

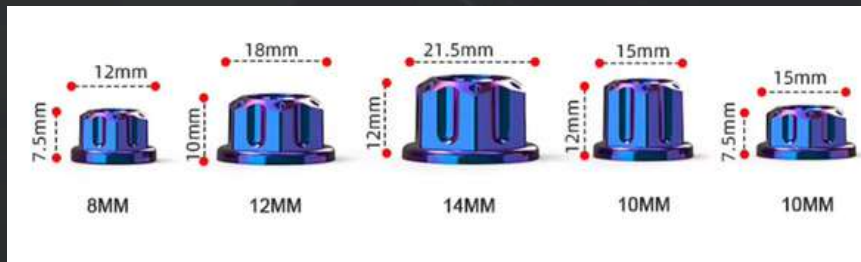

Adorno de lujo Tornillo camaleón

CARACTERÍSTICAS

- Set 48 piezas
- Color camaleón
- Material Abs

S/. 20

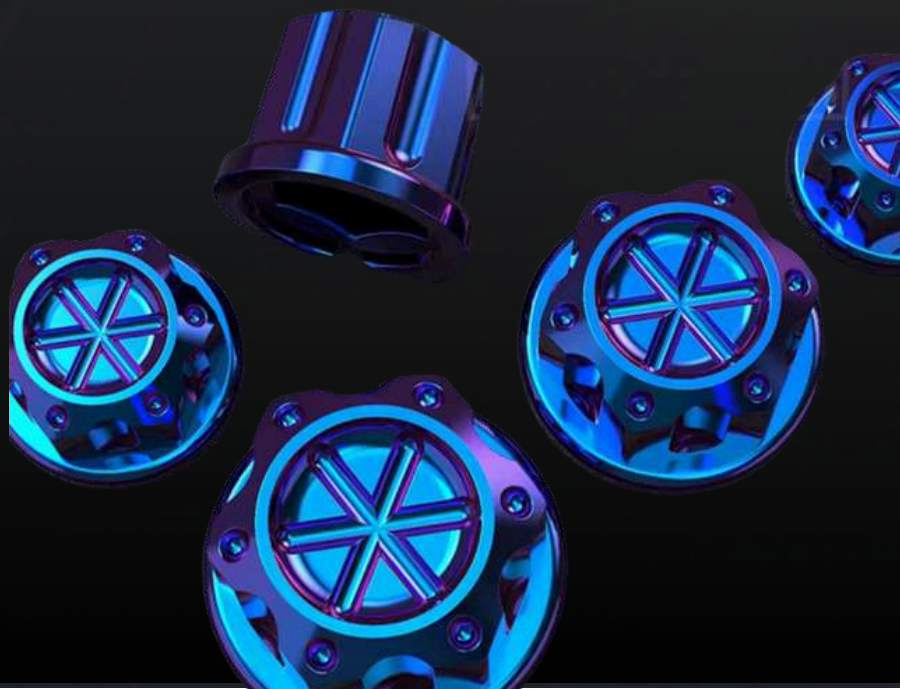

ALERON CON LUZ LED



S/. 55

CARACTERÍSTICAS

- Material ABS
- Fácil de instalar, con sensor solar para su recarga de baterías



CÓD: RV-059



CÓD: RZ-024



MANILLAR BARRACUDA

CARACTERÍSTICAS

- Agarre para manillar de motocicletas.
- Fácil de instalar.

S/. 39



cód: RU5-56



CORTAVIENTO CON LUZ

CARACTERÍSTICAS

- Protector de mano para la moto
- Reduce la fricción del aire con más manos al chocar en velocidad

S/. 95

MANIJA BREMBO



CÓD: **RU5-55**



S/. 260

CARACTERÍSTICAS

- kit de instalacion completo
- Universal para motos deportivas





CÓD: RZ-027



MANIJA RACING UNIVERSAL

CARACTERÍSTICAS

- Manija de frenos para motocicleta
- Facil de instalar

S/. 85



MT15 CÚPULA YAMAHA

CÓD: RV-073



CARACTERÍSTICAS

- Cúpula metalizada para la MT15
- Mejora aerodinámica
- Fácil de instalar
- Colores NEGRO-PLATEADO-ROJO-AZUL

S/. 95





CÓD: RZ-062



SOPORTE PARA EXPLORADORAS

CARACTERÍSTICAS

- 3 colores disponibles
- Universal
- aleacion de metal

S/. 38





cód: RU5-56



SUJETADOR RACING

CARACTERÍSTICAS

- Barra de agarre para tanque
- Facil de instalar
- Aleacion de aluminio

S/. 100



CÓD: RU5-58

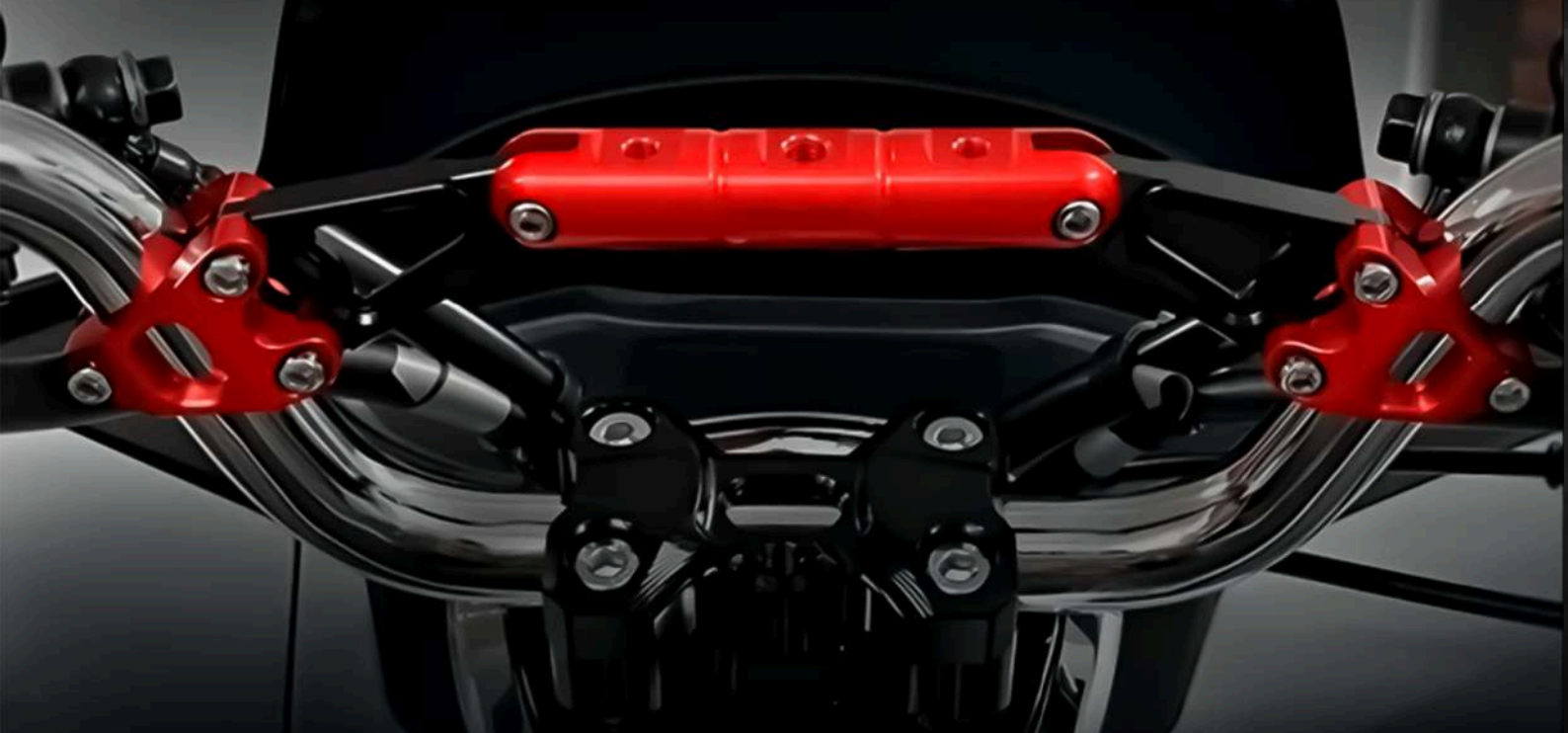

UNIVERSAL
EXTENSION DE TIMON



S/. 70



**CHANGO
MOTORS**

CÓD: RV-021



Protector de Caliper

CARACTERÍSTICAS

- Buena resistencia a la corrosión y suficiente dureza
- Material de aluminio

S/. 120



cód: RV-051



S/. 50

SLIDER PARA TUBO DE ESCAPE

CARACTERÍSTICAS

- Evita que la moto impacte en el piso
- Universal
- resistente





cód: **RU5-56**



S/. 90

SOPORTE DE PATA LATERAL PARA MOTO

CARACTERÍSTICAS

- Mejor agarre para la pata
- Antideslizantes
- proporciona mayor superficie de agarre para distintas zonas





CÓD: RV-052

S/. 100



SLIDER PISTERO

- Material de aleación de aluminio
- Protector anticaídas





CÓD: RU5-56



SLIDER PISTERO MOD 2

CARACTERÍSTICAS

- Material de aleación de aluminio de alta calidad
- Protector anticaídas

S/. 120



**CHANGO
MOTORS**

CÓD: RZ-070



Universal protector de barra

CARACTERÍSTICAS

- Cubierta de amortiguador delantero
- Acero inoxidable



S/.30



CÓD: **RZ-069**



S/. 35

PROTECTOR ESCOICCOY MOD CAMALEON

CARACTERÍSTICAS

- Cubiertas de amortiguadores delanteros de
- Acero inoxidable
- color camaleon

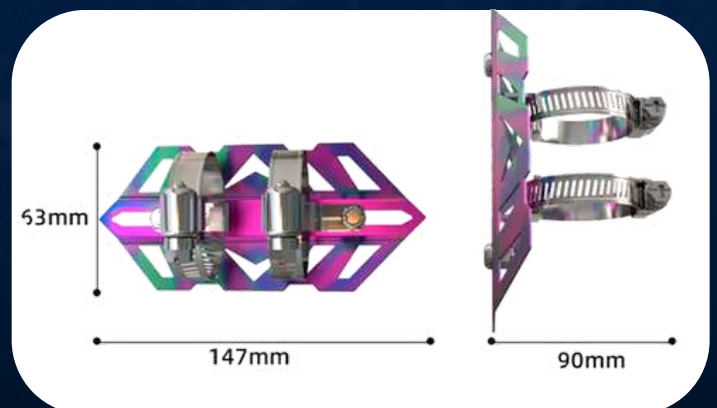



CÓD: RV-052

S / 60

PROTECTOR
TUBO DE ESCAPE
UNIVERSAL

- Material de aleación de aluminio
- Protector anticaídas

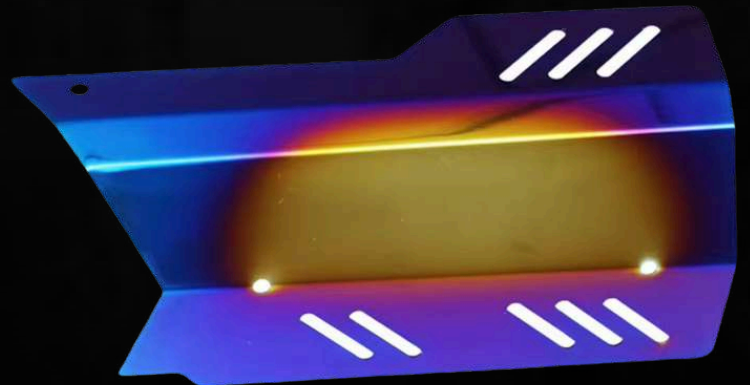



CÓD: RV-007



Protector de Tubo

CARACTERÍSTICAS

- Escudo térmico para evitar quemaduras
- Universal
- 5 colores disponibles

S/. 22





CÓD:RU5-57

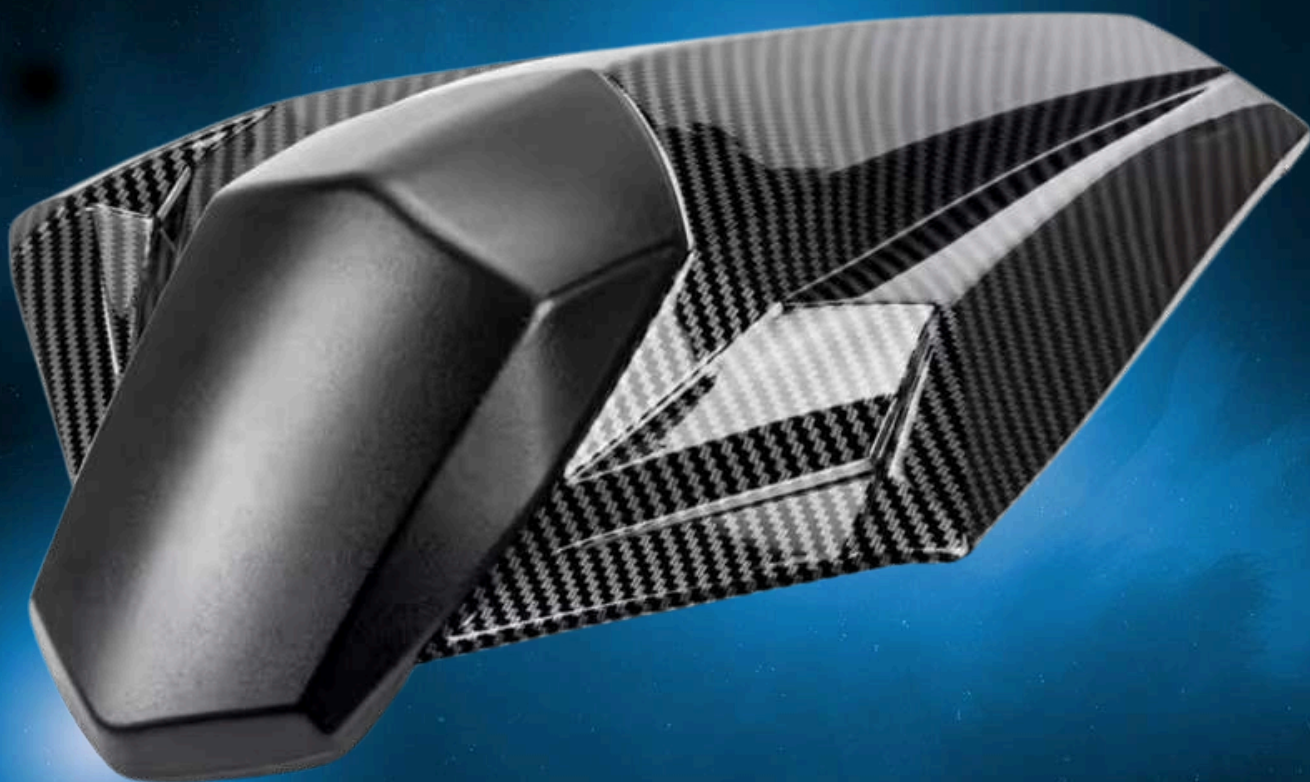

***SOLO SEAT
DEPORTIVA***

CARACTERÍSTICAS

- Cubierto de fibra de carbono
- Material ABS

S/. 110





CÓD: **RV-051**



PORTA PLACA ARTICULADO

CARACTERÍSTICAS

- Diseño graduable
- Aleación de aluminio
- Facil instalacion

S/. 125





**CHANGO
MOTORS**

CÓD: RV-021



Porta Placa Articulada

CARACTERÍSTICAS

S/. 150

- Diseño graduable
- Aleación de aluminio
- Facil instalacion

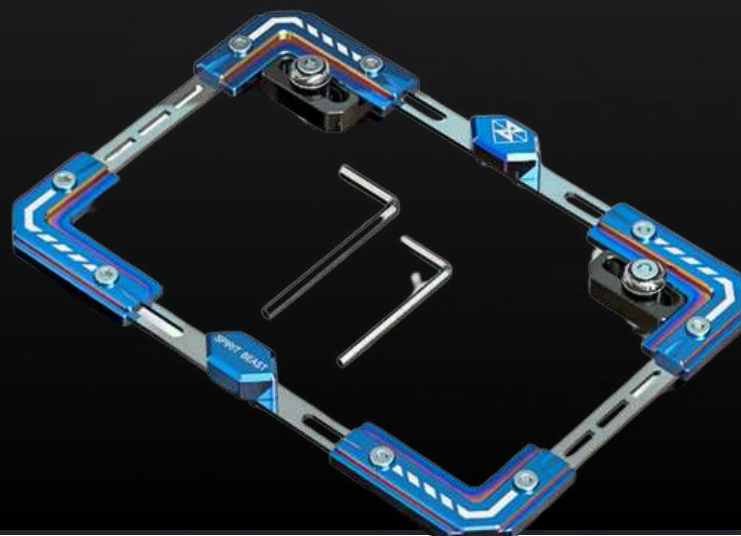



cód: RZ-024



PORTA PLACAS ARTICULADA C/LUZ

CARACTERÍSTICAS

- Agarre para manillar de motocicletas.
- Fácil de instalar.

S/.69



LUCES LED PARA LA MOTO

CÓD: **RV-063**



CARACTERÍSTICAS

- Pack de 4 luces
- Recargables por USB

S/. 49





**CHANGO
MOTORS**

CÓD: RV-015



Tope de eje con luz

LED

S/. 130

CARACTERÍSTICAS

- Buena resistencia a la corrosión y suficiente dureza
- Material de aluminio



CÓD: RE-016



S/. 149

**Tope de eje con luz
LED**

CARACTERÍSTICAS

- Colores surtidos
- Material de aluminio

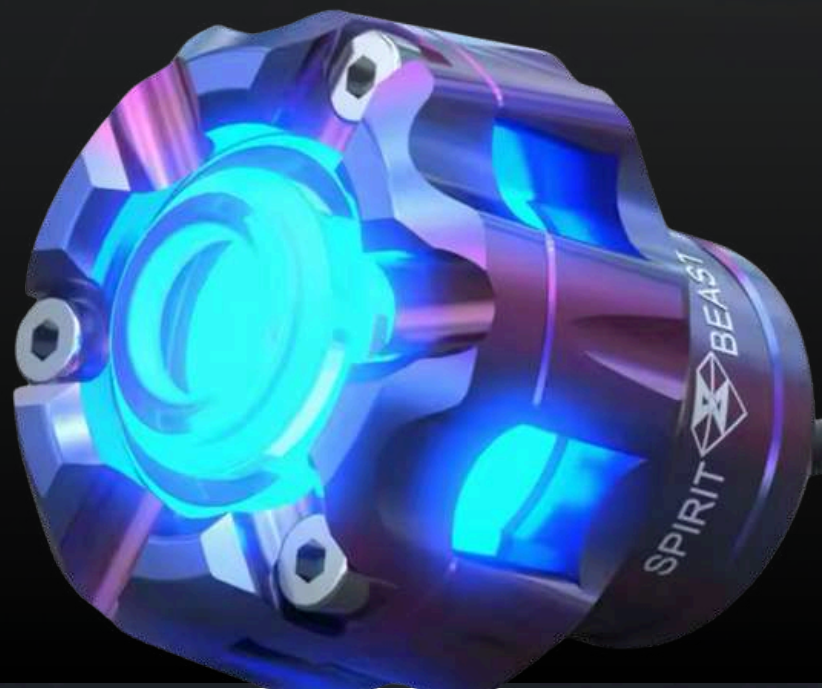



CÓD:RU8-12



ESPEJO NAKED UNIVERSAL

CARACTERÍSTICAS

- Aluminio
- Precio por par
- Colores:dorado-azul-naranja-gris

S/. 49

ESPEJO RACING **DEPORTIVO**

CÓD: **RU5-49**



CARACTERÍSTICAS

- Ajustable 360 grados
- Luz LED intermitente
- Recubierto de fibra de carbono

S/. 125



ESPEJO ALERON PEQUEÑO

CÓD: RZ-044



CARACTERÍSTICAS

- Acabado mate
- Ajustable: Si



S/. 75





CÓD:RU5-33



ESPEJO ALERÓN DEPORTIVA C/LUZ

CARACTERÍSTICAS

- Aluminio
- Precio por par
- Base giratoria
- Incluye tornillos

S/. 89

ESPEJO ALERON GRANDE **DEPORTIVO**

CÓD: **RU5-53**



CARACTERÍSTICAS

- Aluminio
- Base giratoria 360 grados
- Mayor campo de visión

S/. 95





cód: RZ-024



PORTA PLACAS ARTICULADA C/LUZ

CARACTERÍSTICAS

- Agarre para manillar de motocicletas.
- Fácil de instalar.

S / .65



EXPLORADORA MODELO TIGRE

CÓD: RU8-8



CARACTERÍSTICAS

- Precio por par
- 3 modos luminosos
- Luz blanca// luz amarilla// ambas
- A prueba de agua

S/. 65



EXPLORADORA MODELO CALAVERA

CÓD: RU8-10



CARACTERÍSTICAS

- Precio por par
- 3 modos luminosos
- Luz blanca// luz amarilla// ambas
- A prueba de agua



S/. 95



EXPLORADORA 2x2

CÓD: RV-061



CARACTERÍSTICAS

- Precio por par
- 3 modos luminosos
- Luz blanca// luz amarilla// ambas
- A prueba de agua

S/. 90



**CHANGO
MOTORS**



EXPLORADORA 3X3

CÓD: RV-060



CARACTERÍSTICAS

- Precio por par
- 3 modos luminosos
- Luz blanca// luz amarilla// ambas
- A prueba de agua

S/. 110



**CHANGO
MOTORS**



EXPLORADORA 4X4

CÓD: RU11-1



FAROL ALTO



FAROL BAIXO



COMBO

CARACTERÍSTICAS

- Precio por par
- 3 modos luminosos
- Luz blanca// luz amarilla// ambas
- A prueba de agua
- Dos ventiladores traseros



S/. 180



CHANGO
MOTORS



CHANGO
MOTORS



CÓD: **RV-051**



S/. 200

PARLANTE EXPLORADORA

CARACTERÍSTICAS

- Conexión USB - Micro SD
- Bluetooth
- Impermeable
- Trae control remoto





CÓD: RU5-29



Parlante ADVEISE Mod 2

CARACTERÍSTICAS

- Buena resistencia a la corrosión y suficiente dureza
- Material de aluminio

S/. 115



CÓD: RV-021



Parlante Bluetooth Con alarma

CARACTERÍSTICAS

- Resistente al agua
- 2 puertos usb 1 micro SD
- Control remoto con alarma
- Llamada controlada por botón

S/. 110



CÓD: RU5-31



PARLANTE DE METAL ADVEISE

MOD 2

S/. 180

CARACTERÍSTICAS

- Tecnología Bluetooth
- Soporte para radio FM
- Puerto USB con carga rápida

